



ONLINE UPS

Installation and Operating Instructions

a-TroniX UPS Edition One 1kVA, 2kVA, 3kVA



Model	Capacity (VA)	Article number
a-TroniX UPS Edition One 1kVA	1000	9884900
a-TroniX UPS Edition One 2kVA	2000	9885105
a-TroniX UPS Edition One 3kVA	3000	9885106

INTRODUCTION

The publication and copyright of this documentation remain with the company:

AKKU SYS Akkumulator- und Batterietechnik Nord GmbH
Verbindungsweg 23 · 25469 Halstenbek / Hamburg · GERMANY
Telefon +49 4101 | 3 76 76-0 / Fax +49 4101 | 3 76 76-66
info@akkusys.de / www.akkusys.de

Thank you very much

for purchasing our a-TroniX series online UPS.

It is an intelligent, single-phase, high-frequency online UPS and meets the required safety standards.

Due to its excellent electrical performance with a power factor of $\cos \phi$ 1.0, as well as perfect intelligent monitoring and network functions, it meets the world's most advanced level.

With the a-Tronix Series Edition One, your installations are safely protected from power supply problems and the functionality of your equipment is maintained.

Read carefully before use

Read this manual carefully before installation.

It contains important regulations and instructions for the use of this product and provides technical support for the operator of the unit.

All rights reserved

AKKU SYS Akkumulator- und Batterietechnik Nord GmbH cannot be held responsible for any inaccuracies or inappropriate information in this instruction manual.

The information in this document is subject to change without notice, but there is no obligation to update it on an ongoing basis.

We reserve the right to make design and equipment changes to improve the production process or the product.

Table of Contents

	Page
1. Important Safety Warning	4
1.1 Symbols used in this guide	5
1.2 Transportation	5
1.3 Preparation	5
1.4 Installation	5
1.5 Operation	7
1.6 Maintenance, service and faults	7
1.7 Handling of batteries	8
2. Installation and setup	9
2.1 Unpack checking	9
2.2 Device view	9
2.3 Setup the UaPS	12
2.4 UPS start up and turn off	14
3. Operations	19
3.1 Button operation	19
3.2 LCD display	20
3.3 UPS setting	22
3.4 Operational Status and Mode(s)	25
3.5 Alarm or Fault reference code	25
4. Troubleshooting	26
5. Storage and Maintenance	27
6. Options	28
7. Specification	31

1. Important Safety Warning

Be sure to observe all warnings and operating instructions in this manual. Keep this manual in a safe place and read the following instructions carefully before installing and operating the unit.

The operating instructions must be read and understood by all persons and specialists who work with this unit.

Dangerous voltages and high temperatures are present inside the UPS. Observe the local safety instructions and the corresponding laws during installation, operation and maintenance, otherwise personal injury or damage to the equipment may occur. The safety instructions in this manual serve as a supplement to the local safety instructions. Our company accepts no liability for damage caused by failure to observe the safety instructions.

The UPS, as well as the associated components, may only be used for the purpose corresponding to their design - for supplying electrical consumers from a primary energy source and for short-term supply of the consumers from a secondary energy source, which do not exceed the rated power in total. Any other use or use beyond this is considered improper and may result in personal injury, property damage and/or damage to the appliance.

1.1 Symbols used in this guide

In these operating instructions, the abbreviation **UPS** stands for:
Uninterruptible **P**ower **S**upply.

Accumulators are usually used as energy storage for a UPS system. These are also colloquially referred to as accumulators or batteries.

Warnings and notes are indicated by the corresponding symbols (pictograms) and must be observed:

WARNING!



Warning of dangerous electrical voltage.



General warning of danger points.



Warning when handling accumulators.

NOTE:



This symbol indicates texts, notes or tips. Failure to take precautionary measures may result in damage to the product and/or its functions or to an object in its vicinity.

ENVIRONMENT:



Indicates recycling information.



Indicates assemblies or parts that must be disposed of properly.
Do not dispose of them in the household waste.

1.2 Transportation

- Please transport the UPS system only in the original packaging to protect it from shocks and impacts.

1.3 Preparation



- If the UPS system is brought directly from a cold to a warm environment, condensation may occur. The UPS system must be absolutely dry before it is installed. Please allow at least 2 hours for the UPS to acclimatise to the environment.
- Do not install the UPS system near water or in humid environments and generally keep liquids away from the UPS system.
- Do not install the UPS system near a heater or in a place where it is exposed to direct sunlight.
- Do not block any ventilation openings in the UPS enclosure and maintain the minimum distances from neighbouring equipment or walls necessary for ventilation.
- Never operate the UPS in an explosive and/or unventilated environment.



1.4 Installation



- To avoid electrical hazards, the UPS should only be connected in a de-energised state.
- Do not connect any loads to the UPS that could overload the unit.
- Lay cables so that no one can step on them or trip over them and keep them as short as possible.
- Do not connect any household or handcraft appliances such as hair dryers, fan heaters, hoovers, drills etc. to the output sockets of the UPS.
- Only connect the UPS system to an earthed socket outlet that is easily accessible and close to the UPS system.
- Please use only VDE-tested, CE-marked mains cables (e.g. the mains cable of your computer) to connect the UPS system to the mains socket of the house installation (earthed socket).
- Please use only VDE-tested, CE-marked mains cables to connect the loads to the UPS system.
- Use generally installation-appropriate tools with insulated handles.
- During installation, make sure that the sum of the leakage current of the UPS and the connected devices does not exceed 3.5mA.

1.5 Operation

- Do not disconnect the mains cable from the UPS system or the socket outlet of the house installation (earthed socket outlet) during operation. This will cancel the protective earthing of the UPS system and all connected loads.



- The UPS system has its own internal power source (batteries). The UPS output sockets or the output terminal block can be live even if the UPS system is not connected to the socket of the house installation.
- In order to fully disconnect the UPS system, first press the OFF/Enter button to disconnect the mains.

1.6 Maintenance, service and faults

- The UPS system operates with dangerous voltages. Repairs may only be carried out by qualified maintenance personnel.
- Only persons who are sufficiently familiar with accumulators and the necessary precautions may replace accumulators and supervise the work. Unauthorised persons must be kept away from the accumulators.



Caution – risk of electric shock.

Accumulators can cause electric shock and have a high short-circuit current. When handling accumulators, please take the following necessary precautions:

- Remove wristwatches, rings and other metal objects.
- Only use tools with insulated handles.
- Before performing any type of service and/or maintenance, disconnect the batteries and make sure that there is no current and that there is no dangerous voltage on the terminals of high-power capacitors such as BUS capacitors. Even after disconnecting the unit from the mains (domestic electrical socket), the components inside the UPS system are still connected to the battery and are under dangerous electrical voltage.
- Before touching, make sure that there is no voltage present!
- Replace the fuse only with the same type and amperage to avoid fire hazard.
- Do not dismantle the UPS system.

1.7 Handling of batteries



- When changing batteries, always insert the same number and type of batteries.
- Batteries or their connections can cause electric shocks.
- If short circuits occur on accumulators, touching the live parts can cause severe burns.



- Batteries should never be brought into contact with heat sources or flames. Do not attempt to dispose of the batteries by burning them. There is a risk of explosion!



- Do not open or destroy any batteries. The released electrolyte can cause injuries to the skin and eyes (caustic hazard). It is toxic and dangerous to humans and the environment.
- Defective accumulators must be disposed of in an environmentally friendly manner. Do not throw them in the household waste under any circumstances and observe the local disposal regulations. Take advantage of the certified and professional recycling service of our AkkuSys team. For more information, contact us on the order hotline +49 4101/376760, at info@akkusys.de or use the QR code.



2. Installation and setup

NOTE:



Please check the unit before installation. Make sure that nothing in the packaging is damaged.



The packaging is recyclable. After unpacking, please keep it for reuse or dispose of it properly.

2.1 Unpack checking

- Do not tip the UPS when removing it from the packaging. A general risk of tipping always exists with units with a high centre of gravity.
- Check whether the UPS has been damaged during transport and do not switch on the UPS if damage is detected. Please contact the dealer immediately.
- Check the accessories against the packing list and contact the dealer if any parts are missing. Accessories include:
UPS user manual, software suite CD, USB cable, Mains cable (input and output), RS232 cable.

2.2 Device view

Nameplate

On the type plate of the UPS you will find the following information:

Example: a-tronix UPS Edition One 1 kVA – Model:

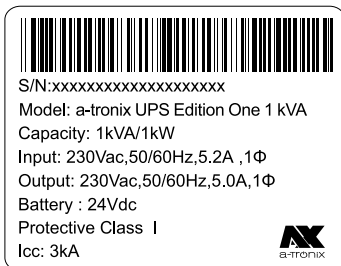

- the serial number
- the model
- the capacity of the unit
- Connection conditions input
- Connection conditions output
- the battery power
- the protection class
- Indication of the short circuit currents



Always compare the type plate of the unit and these operating instructions to ensure that they are the same.

This prevents incorrect use of the instructions and the UPS.

Front view

Example Edition One 1kVA

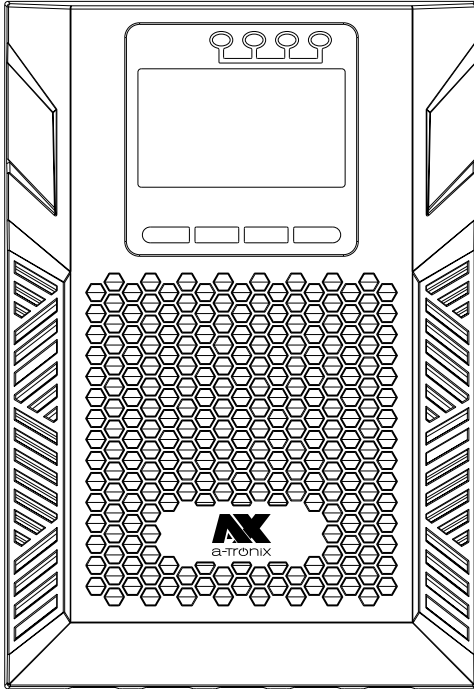

Example Edition One 2kVA

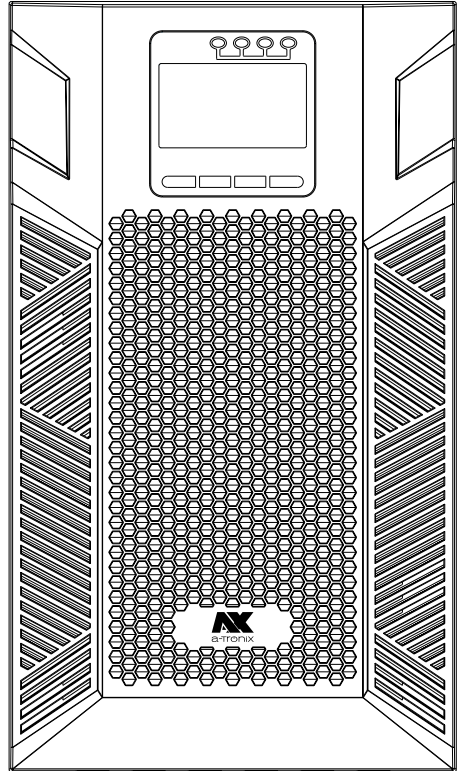

Rear view

Example Edition One 1kVA

Example Edition One 2kVA

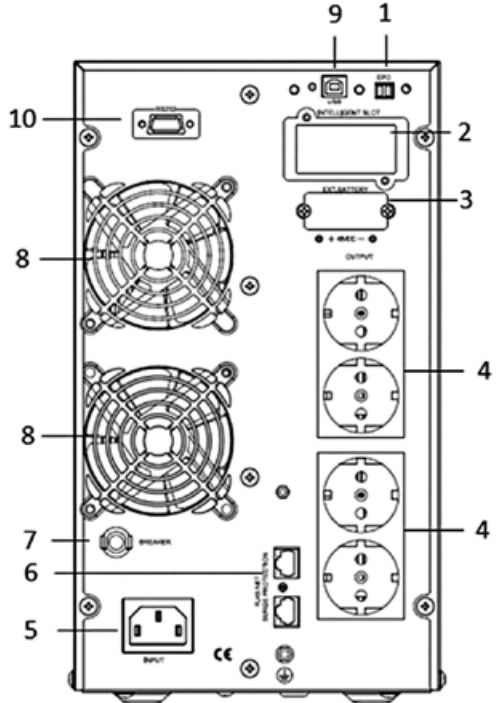
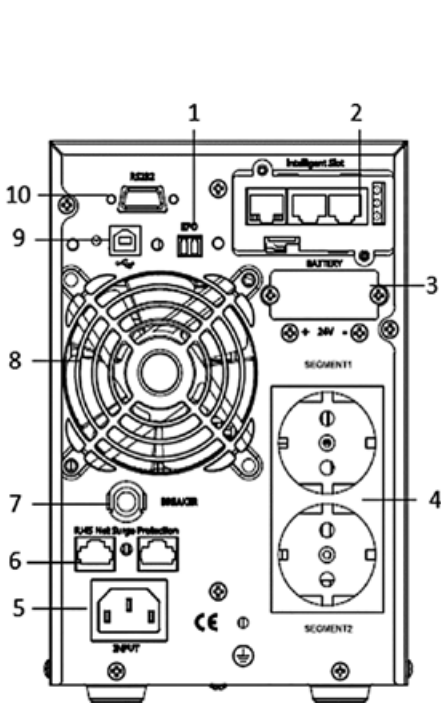

Edition One 1kVA, 2kVA, 3kVA

- (1) EPO-connection (EMERGENCY POWER OFF)
- (2) Expansion module slot (Intelligent Slot)
- (3) External battery bank connection
- (4) Load connection (UPS output)
- (5) Mains connection (UPS input)
- (6) RJ45 network plug connector
- (7) Fuse „BREAKER“
- (8) Fan
- (9) USB connection
- (10) RS232 connection

2.3 Setup the UPS

Step 1: Battery installation (internal) Example 1kVA

Before you switch on the UPS, you must equip it with batteries according to the specification. To do this, please proceed as follows:

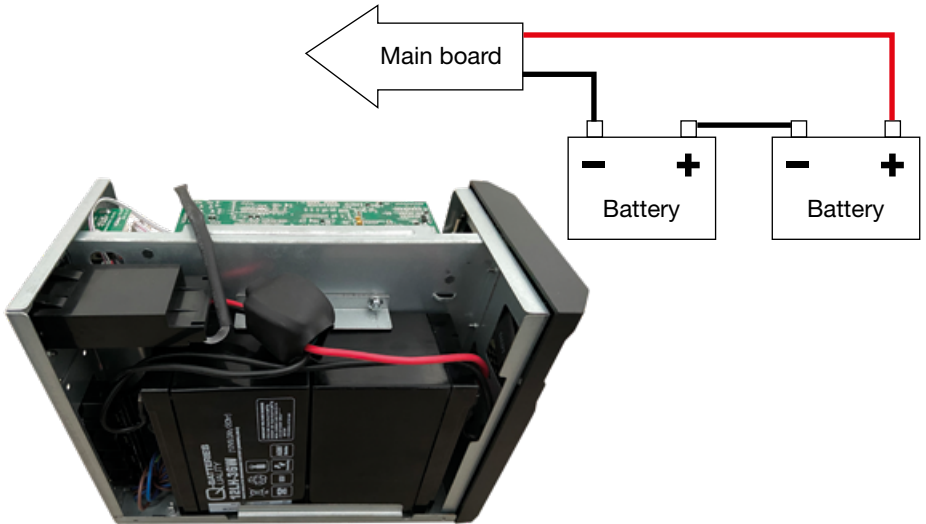

Step 2: UPS input connection

- Only connect the UPS to a two-pin, three-pole, earthed socket. Avoid the use of extension cables.
- For models with 208/220/230/240VAC:
The mains cable is included with the UPS.

Step 3: UPS output connection

- For earthed type outlets, you can simply plug the power supplies of your appliances into the outlets of your UPS.
- For terminal-type inputs or outputs, please follow these steps for wiring configuration:
 - a) Remove the small cover of the terminal block.
 - b) Use 2.5mm² mains cable for 3KVA (200/208/220/230/240VAC) models.
 - c) After completing the wiring, check that the wires are securely fastened.
 - d) Reattach the small cover to the back wall.

Step 4: Communication link

Communication port:

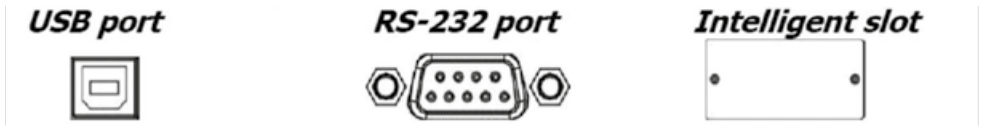

To allow for unattended UPS shutdown/start-up and status monitoring, connect the communication cable one end to the USB/RS-232 port and the other to the communication port of your PC. With the monitoring software installed, you can schedule UPS shutdown/start-up and monitor UPS status through PC.

The UPS is equipped with intelligent slot perfect for either SNMP or Relay card. When installing either SNMP or Relay card in the UPS, it will provide advanced communication and monitoring options.



NOTE:

USB port and RS-232 port can't work at the same time.

Step 5: Turn on the UPS

Press the ON button on the front panel for two seconds to power on the UPS.



NOTE:

The battery charges fully during the first five hours of normal operation. Do not expect full battery run capability during this initial charge period.

Step 6: Install software

For optimum protection of the computer system, install the UPS monitoring software to fully configure the UPS shutdown.

You will find the corresponding software on our homepage.

In the accessory bag you will find the software installation instructions of the long-established software operator Megatec which you can download from the website megatec.com.tw (Software UPSilion 2000).

There you will also find the required serial number.

We offer this software as an additional option to our own software.

Step 7: External battery connection

If your UPS is not including batteries:
Please connect external batteries as below chart:

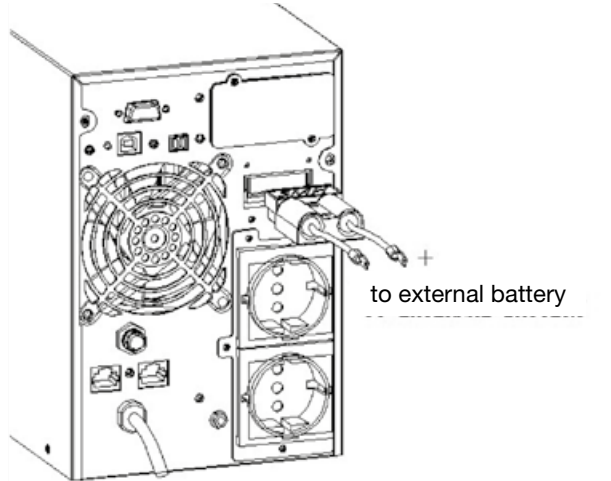

For a detailed description, please refer to the operating instructions for our a-TroniX series extended battery pack.

2.4 UPS start up and turn off

Start up operation

(1) Turn on the UPS in line mode.



NOTE:

Verify that the total equipment ratings do not exceed the UPS capacity to prevent an overload alarm.

- (a) Once mains power is plugged in, the UPS will charge the battery, at the moment, the LCD shows that the output voltage is 220, which means the UPS automatically start the inverter. If it is expected to change to bypassmodel, you can Press “OFF” key.
- (b) Press and hold the ON key for more than three seconds to start the UPS, then it will start the inverter.
- (c) Once started, the UPS will perform a self-test function, LED will light and go out circularly and orderly. When the self-test finishes, it will come to line mode, the corresponding LED lights, the UPS is working in line mode.

(2) Turn on the UPS by DC without mains power.

- a) When mains power is disconnected, press and hold the ON key for more than half a second to start UPS.
- b) The operation of the UPS in the process of start is almost the same as that when mains power is in. After finishing the self-test, the corresponding LED lights and the UPS is working in battery mode.

Turn off operation

(1) Turn off the UPS in line mode.

- a) Press and hold the OFF key for more than half a second to turn off the UPS and inverter.
- b) After the UPS shutdown, the LEDs go out and there is no output. If output is needed, you can set bps (Bypass) „ON“ on the LCD setting menu.

(2) Turn off the UPS by DC without mains power.

- a) Press and hold the OFF key for more than half a second to turn off the UPS.
- b) When turning off the UPS, it will do self-testing firstly. The LEDs light and go out circularly and orderly until there is no display on the cover.

Operation and Display panel

The control and display panel, shown in the following figure, is located on the front of the unit. It includes three indicators, four function keys and an LCD display that shows the operating status and input/output power information.

All operating and display elements of the unit are reduced to the operating unit (PANEL) and allow for a clear display of all status data or unit information or the operation of the UPS (system).



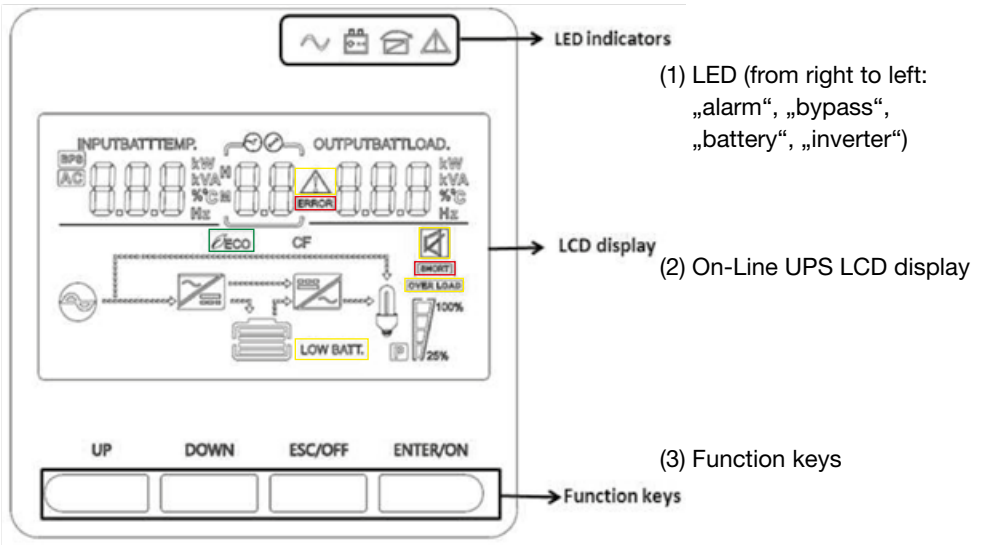

All important data can be displayed, called up or set via the operating unit of the UPS. All unit information and parameters are displayed and parameters via the LCD DISPLAY. This also includes operating parameters, status data or error codes. The LCD DISPLAY also has a backlight.

Navigation and input is done via the keypad located at the bottom.

LCD control panel introduction



LED Indicator

Indicator	Description
 Red	On – The UPS has an active alarm or fault.
 Yellow	The UPS is in Bypass mode. On – The UPS is operating normally onbypassduring High Efficiency operation.
 Yellow	On – The UPS is in Battery mode.
 Green	On - The UPS is operating normally.



NOTE:

When power on or startup , these indicators will turn on and off sequentially.

Function Keys

Function Key	Description
ESC / OFF	To turn off the ups or exit setting mode without save
UP	To turn off the ups or exit setting mode without save
DOWN	To go ton ext selection
ENTER / ON	To turn on the ups or confirm the selection in setting mode or enter setting mode

LCD-Display Icons

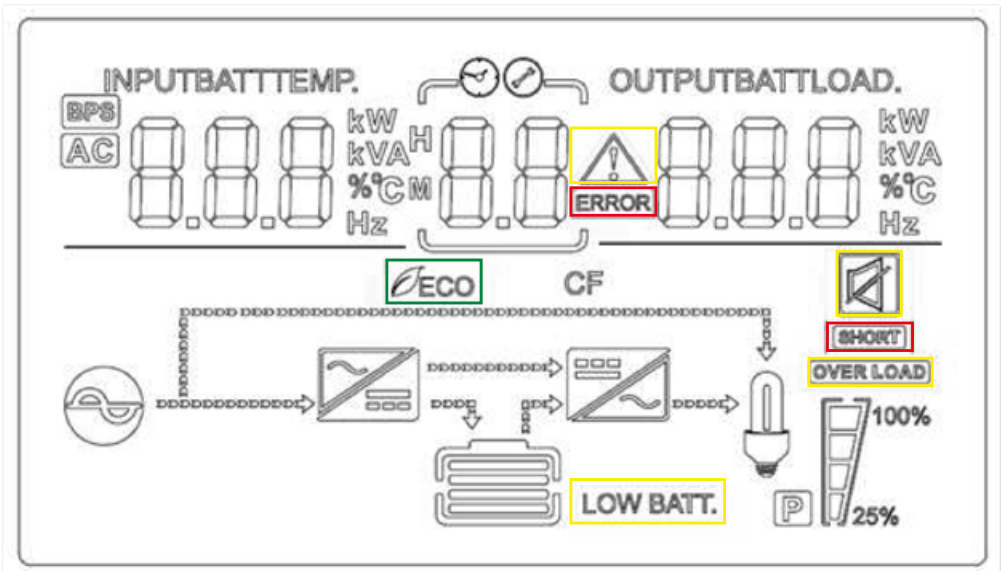

Icon	Function description
	Indicates the AC input.
	Indicate input voltage, input frequency, PV voltage, battery voltage and temperature

Icon	Function description								
	<p>Configuration Program and Fault Information</p> <p>Indicates the setting programs.</p>								
	<p>Indicates the warning and fault codes.</p> <p>Warning: flashing with warning code</p> <p>Fault: lighting with fault code</p>								
	<p>Output Information</p> <p>Indicate output voltage, output frequency, load percent, load in VA, load in Watt and discharging current.</p>								
	<p>Battery Information</p> <p>Indicates battery level by 0–24%, 25–49%, 50–74% and 75–100% in battery mode and charging status in line mode.</p>								
In AC mode, it will present battery charging status.									
Status	Battery capacity	LCD Display							
Constant Current mode	0–24%	4 bars will flash in turns.							
	25–49%	Bottom bar will be on and the other three bars will flash in turns.							
	50–74%	Bottom two bar will be on and the other two bars will flash in turns.							
	75–100%	Bottom three bar will be on and the top will flash.							
	<p>Load Information</p> <p>Indicates overload.</p>								
	<p>Indicates the load level by 0–24%, 25–49%, 50–74% and 75–100%.</p> <table border="1"> <thead> <tr> <th>0%~25%</th> <th>25%~50%</th> <th>50%~75%</th> <th>75%~100%</th> </tr> </thead> <tbody> <tr> <td></td> <td></td> <td></td> <td></td> </tr> </tbody> </table>	0%~25%	25%~50%	50%~75%	75%~100%				
0%~25%	25%~50%	50%~75%	75%~100%						
	<p>Mode Operation Information</p> <p>Indicates unit connects to the mains.</p>								
	Indicates load is supplied by utility power.								
	Indicates the utility charger circuit is working.								
	Indicates the DC/AC inverter circuit is working.								
	<p>Mute Operation</p> <p>Indicates unit alarm is disabled.</p>								

3. Operations

3.1 Button operation

Button	Function
ON / ENTER	<ul style="list-style-type: none">■ Turn on the UPS: Press and hold ON button for at least 2 seconds to turn on the UPS.
	<ul style="list-style-type: none">■ Confirm current settings: When the UPS enters the setting mode, must press this button to confirm the settings value what you want, nest press up/down button to changes ettings information.
	<ul style="list-style-type: none">■ Out off bypass mode: when the UPS enter to bypass mode, press and hold this button it will switch to normal mode.
OFF / ESC	<ul style="list-style-type: none">■ Turn off the UPS: Press and hold this button at least 2 seconds to turn off the UPS in battery mode. UPS will be in standby mode under power normal or transfer to Bypass mode if the Bypass enable setting by pressing this button.
	<ul style="list-style-type: none">■ Exit setting mode: Press this button to confirm selection and exit setting mode when LCD display the last selection in UPS setting mode.
UP	<ul style="list-style-type: none">■ Up key: Press this button to display previous selection in UPS setting mode.
DOWN	<ul style="list-style-type: none">■ Down key: Press this button to display next selection in UPS setting mode.
UP + DOWN	<ul style="list-style-type: none">■ Setting mode: Press and hold this buttons for 5 seconds to enter UPS setting mode.

3.2 LCD display

There are 8 interfaces available in the LCD display:

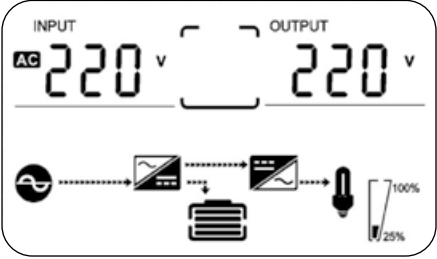
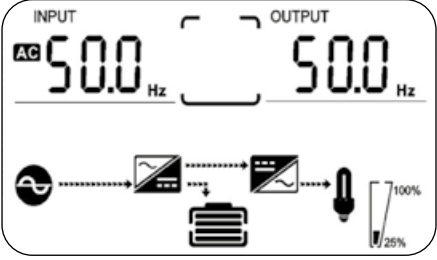
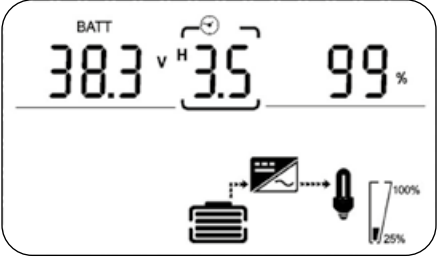
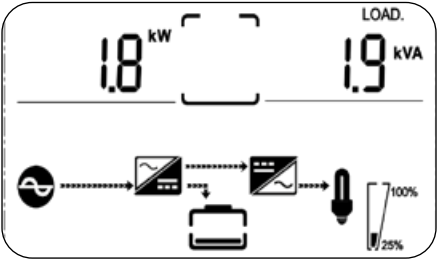
Item	Interface Description	Content Displayed
01	Input voltage & Output voltage	
02	Input frequency & Output frequency	
03	Battery voltage & Battery capacity	
04	Load	

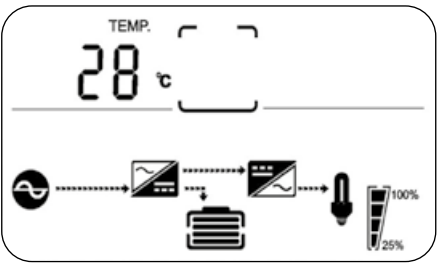
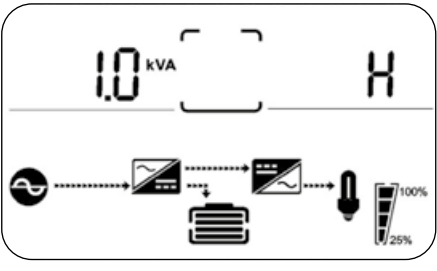
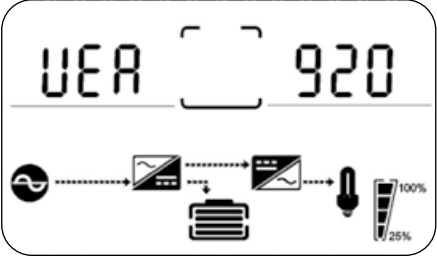
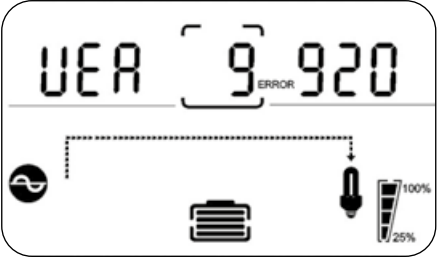
Item	Interface Description	Content Displayed
05	Environment Temperature	 <p>The LCD display shows 'TEMP.' above '28 °C'. Below the display is a system status diagram with icons for AC input, rectifier, inverter, battery, and a temperature gauge.</p>
06	UPS model	 <p>The LCD display shows '1.0 kVA' and 'H'. Below the display is a system status diagram with icons for AC input, rectifier, inverter, battery, and a temperature gauge.</p>
07	Firmware Version	 <p>The LCD display shows 'UER' and '920'. Below the display is a system status diagram with icons for AC input, rectifier, inverter, battery, and a temperature gauge.</p>
08	Alarm Code (Warning Message) All alarm codes are present when abnormal behavior(s) occur(s)	 <p>The LCD display shows 'UER', '9 ERROR', and '920'. Below the display is a system status diagram with icons for AC input, battery, and a temperature gauge. A dashed line connects the '9 ERROR' to the temperature gauge icon.</p>

3.3 UPS settings

The UPS has setting functions. This user settings can be done under any kind of UPS working mode. The setting will take effect under certain condition. Below table describes how to set the UPS.

The setting function is controlled by 4 buttons (UP, DOWN, ON / ENTER, OFF / ESC):

UP ▲ + OFF / ESC ▼ goes into the setting page.

ON / ENTER confirm the settings options.

UP ▲ + DOWN ▼ value adjustment Or for choosing different pages.



After the UPS turn ON, press buttons ▲ + ▼ for 5 seconds and then goes into the setting interface page.





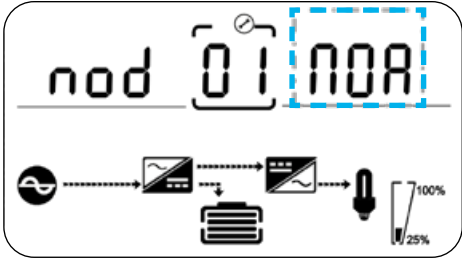

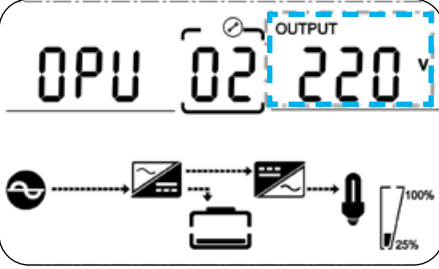
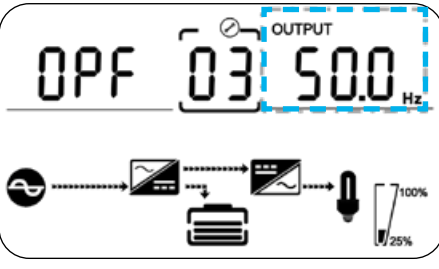
NOTE:

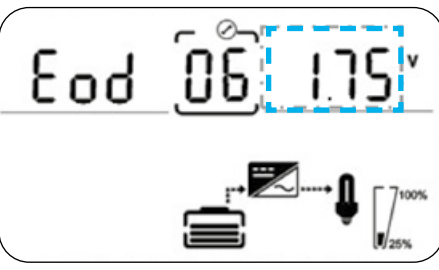
To exit the setting mode and confirm your selection, press the „DOWN“ button until the LCD displays the last selection in UPS setting mode. The LCD then jumps back to the display in power-on mode.

Item	Interface Description	Content Displayed
01	<p>Mode setting Press Enter button to change the setting (ECO or NOR or CF or GEN):</p> <p>ECO – UPS runs in bypass mode NOR – Normal mode CF – frequency converter mode GEN – the UPS can be connected to a generator</p> <p>Press UP ▲ button to select the previous setting.</p> <p>Press DOWN ▼ button to select the next setting.</p>	

Item	Interface Description	Content Displayed
02	<p>Output voltage setting Press Enter button to change the setting (208, 220, 230, 240).</p> <p>Press UP ▲ button to select the previous setting.</p> <p>Press DOWN ▼ button to select the next setting.</p>	
03	<p>Frequency setting Press Enter button to change the setting (50 oder 60 Hz).</p> <p>Press UP ▲ button to select the previous setting.</p> <p>Press DOWN ▼ button to select the next setting.</p>	
04	<p>Battery capacity setting Press Enter button to change the setting (Battery capacity range is 1–200Ah).</p> <p>Press UP ▲ button to select the previous setting.</p> <p>Press DOWN ▼ button to select the next setting.</p>	
05	<p>Battery EOD voltage setting Press Enter button to change the setting (1.60/1.70/1.75/1.80).</p> <p>Press UP ▲ button to select the previous setting.</p> <p>Press DOWN ▼ button to select the next setting.</p>	

Item	Interface Description	Content Displayed
06	<p>Bypass voltage upper limit setting Press Enter button to change the setting (The bypass voltage upper limit range is 230–264 Vac).</p> <p>Press UP ▲ button to select the previous setting.</p> <p>Press DOWN ▼ button to select the next setting.</p>	
07	<p>Bypass voltage lower limit setting Press Enter button to change the setting (The bypass voltage lower limit range is 170–220 Vac).</p> <p>Press UP ▲ button to select the previous setting.</p> <p>Press DOWN ▼ button to select the next setting.</p>	
08	<p>Mute setting Press Enter button to change the setting (ON or OFF).</p> <p>Press UP ▲ button to select the previous setting.</p> <p>Press DOWN ▼ button to save and exit the setup.</p>	
09	<p>BYPASS enable/disable setting Press Enter button to change the setting (ON or OFF).</p> <p>Press UP ▲ button to select the previous setting.</p> <p>Press DOWN ▼ button to save and exit the setup.</p>	

3.4 Operational Status and Mode(s)

Item	Content Displayed	Item	Content Displayed
2	Standby Mode	8	Inverter is starting up
3	No Output	9	ECO Mode
4	Bypass Mode	10	EPO Mode
5	Utility Mode	11	Maintenance Bypass Mode
6	Battery Mode	12	Fault Mode
7	Battery Self-diagnostics	13	Generator Mode

3.5 Alarm or Fault reference code

Event log	UPS Alarm Warning	Buzzer	LED
1	Rectifier fault	Beep continuously	Fault LED lit
2	Inverter fault (Including Inverter bridge is shorted)	Beep continuously	Fault LED lit
9	Fan fault	Beep continuously	Fault LED lit
12	Selftest fault	Beep continuously	Fault LED lit
13	Battery Charger fault	Beep continuously	Fault LED li
15	DC Bus over voltage	Beep continuously	Fault LED lit
16	DC Bus below voltage	Beep continuously	Fault LED lit
17	DC bus unbalance	Beep continuously	Fault LED lit
18	Soft start failed	Beep continuously	Fault LED lit
19	Rectification model / Over Temperature	Twice per second	Fault LED lit
20	Inverter model Over Temperature	Twice per second	Fault LED lit
26	Battery over voltage	Once per second	Fault LED blinking
29	Output Short-circuit	Once per second	Fault LED blinking
30	Input current limit	Once per second	Fault LED blinking
31	Bypass over current	Once per second	BPS LED blinking
32	Overload	Once per second	INV or BPS LED blinking
33	No battery	Once per second	Battery LED blinking
34	Battery under voltage	Once per second	Battery LED blinking
35	Battery low pre-warning	Once per second	Battery LED blinking
36	Over load time out	Once per 2 seconds	Fault LED blinking
37	DC component over limit.	Once per 2 seconds	INV LED blinking
39	Mains volt. Abnormal	Once per 2 seconds	Battery LED lit
40	Mains freq. abnormal	Once per 2 seconds	Battery LED lit
41	Bypass Not Available		BPS LED blinking
42	Bypass out of tracking range		BPS LED blinking
45	EPO Enable	Beep continuously	Fault LED lit

4. Troubleshooting

If the UPS system does not operate correctly, please solve the problem by using the Troubleshooting Chart:

Symptom	Possible cause	Remedy
No indication and alarm even though the mains is normal.	The AC input power is not connected well.	Check if input power cord firmly connected to the mains.
	The AC input is connected to the UPS output.	Plug AC input power cord to AC input correctly.
Alarm code is shown as „33“ and battery led blinking.	The external or internal battery is incorrectly connected.	Check if all batteries are connected well.
Alarm code is shown as „26“ and battery led blinking.	Battery voltage is too high or the charger is fault.	Contact your dealer.
Alarm code is shown as „34“ and battery led blinking.	Battery voltage is too low or the charger is fault.	Contact your dealer.
Alarm code is shown as „32“ and INV or BYPASS led blinking.	UPS is overload.	Remove excess loads from UPS output.
Alarm code is shown as „29“ and FAULT led light.	The UPS shut down automatically because short circuit occurs on the UPS output.	Check output wiring and if connected devices are in short circuit status.
Alarm code is shown as „9“ and FAULT led light.	Fan fault.	Contact your dealer.
Alarm code is shown as „01, 02, 15, 16, 17, 18“	A UPS internal fault has occurred.	Contact your dealer.
Battery backup time is shorter than nominal value	Batteries are not fully charged.	Charge the batteries for at least 5 hours and then check capacity. If the problem still persists, consult your dealer.
	Batteries defect.	Contact your dealer to replace the battery.

5. Storage and Maintenance

Operation

The UPS system does not contain any user-serviceable parts. When the battery life is exceeded, the batteries must be replaced.

In this case, please contact your dealer.

Take advantage of the certified and professional recycling service offered by our AkkuSys team. For further information, please contact us on the order hotline +49 4101/376760, at info@akkusys.de or use the QR code.



Be sure to return the used battery in the replacement battery packaging to a recycling centre or send it to your dealer. Do not dispose of it in the household waste.



The packaging is recyclable. Keep it for reuse or dispose of it properly.



Storage

Before storing, charge the UPS 5 hours. Store the UPS covered and upright in a cool, dry location. During storage, recharge the battery in accordance with the following table:

Storage Temperature	Recharge Frequency	Charging Duration
-25°C – 40°C	Every 3 months	1–2 hours
40°C – 45°C	Every 2 months	1–2 hours

6. Options

SNMP-Card:

The SNMP card integrates the UPS into a network. After assigning its own IP address, the UPS can be accessed from any location, which is particularly interesting for remote administration/maintenance of the system.

It can easily be inserted into the SNMP slot (INTELLIGENT SLOT) of the UPS and only needs to be connected with a network cable.

- Loosen the two screws (on each side of the card).
- Carefully insert the SNMP card and secure the screws.

Relaycard:

The internal mini relay card is used as an interface for UPS peripheral monitoring. The contact signals reflect the operating status of the UPS. The card is connected to peripheral monitoring devices via the terminal block to effectively monitor the real-time status of the UPS and provide timely status feedback when an abnormal situation occurs (e.g. UPS failure, mains interruption, UPS bypass, etc.). It is installed in the intelligent slot of the UPS.

The relay board has 6 output ports and one input port.

Please refer to the following table for details.

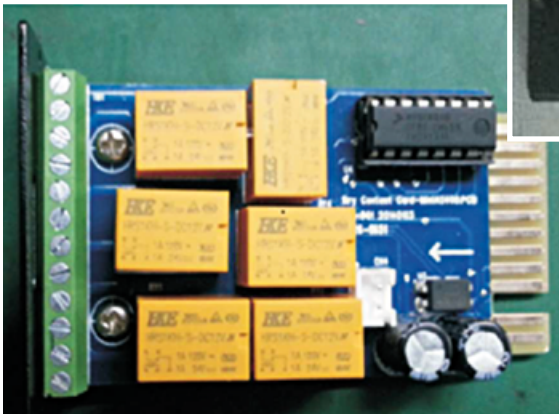

Emergency Power Off (EPO)

EPO is used to shut down the UPS remotely. This function can be used to shut down the load and the UPS through a thermal relay, e.g. in case of room overtemperature. When EPO is activated, the UPS immediately switches off the output and all its current transformers. The UPS remains switched on to report the fault.

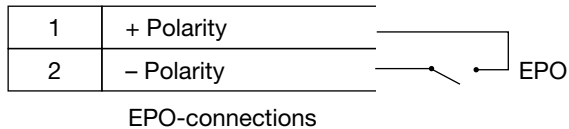

NOTE:

Depending on the user configuration, the pins must be short-circuited or opened for the UPS to continue running. To restart the UPS, reconnect the pins of the EPO connector (open them again) and switch on the UPS manually. The maximum resistance in the shorted loop is 10 ohms.

Always test the EPO function before applying your critical load to avoid accidental loss of load. Leave the EPO plug installed on the EPO connector of the UPS even if the EPO function is not needed.

Load Segments

Load segments are sets of receptacles that can be controlled by power management software or through the display, providing an orderly shutdown and startup of your equipment. For example, during a power outage, you can keep critical equipment running while you turn off other equipment. This feature allows you to save battery power.

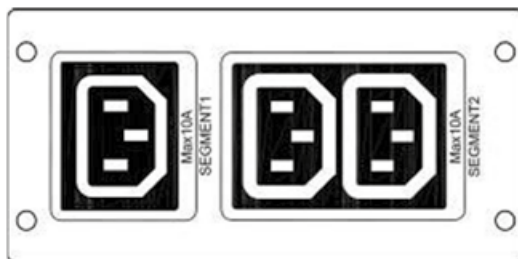

Lastsegment 1:

Die Spannung der Abwurfatterie dieses Segments kann über das LCD eingestellt werden.

Lastsegment 2:

Das Ende der Entladung der Abwurfatterie (EOD).

Extended Battery Pack

Every UPS system requires an energy storage device to supply the loads with stored energy during a power failure. Extended Battery Packs are used either as the sole energy storage device or as a supplement to the internal battery bank in order to achieve an extension of the autonomy time and/or to adapt to the required load conditions.

Due to the different customer requirements, the battery packs are individually designed in terms of size and equipment. In addition, some standard sizes are offered.

The Edition One series is already prepared for the adaptation of an extended Battery Pack.

7. Specification

				UPS Edition One		
Model	1 kVA	2 kVA	3 kVA			
Capacity						
Phases				1:1		
Capacity (KVA)	1	2	3			
Capacity (W)	1000	2000	3000			
Power factor output (cos phi)				1,0		
Transfer time (ms)				Mains mode to battery mode: 0 ms Inverter mode to bypass mode: 4 ms		
Input						
Rated voltage (V AC)				208 / 220 / 230 / 240		
Voltage range (without battery) (V AC)				110~300 (176~264 @ 100%)		
Frequency (Hz)				40~70		
Power factor input				≥0.99		
Nominal voltage (V DC)	24	48	72			
Standard battery (pcs x Ah) (not included)	2 x 9	4 x 9	6 x 9			
Charging current max (Default)				1		
Output						
Voltage (V AC)				208 / 220 / 230 / 240		
Frequency (Hz)				Mains mode: 46~54Hz oder 56~64Hz, Battery mode: (50/60±0.1%)Hz		
Waveform				Pure Sinewave		
Crest factor				3:1		
Others						
Dimensions (mm) w x d x h	144 x 399 x 209	191 x 460 x 337				
Net weight (kg)	9,3	19,5	24,5			
Noise level (dB (A))				<50 db 1 meter		
Efficiency (%) AC-AC	88	90	90			
Efficiency (%) DC-DC				85		
Operating temperature				0°C~40°C		
Storage temperature				-25°C~55°C		
Relative humidity (non condensing)				20~90%		
Installation height				< 1500m		
IP rating				I		
Standards				IEC/EN62040-1, IEC/EN60950-1 IEC/EN62040-2, IEC61000-4-2, IEC61000-4-3, IEC61000-4-4, IEC61000-4-5, IEC61000-4-6, IEC61000-4-8		

Other manufacturers and product ranges you will find in our AKKU SYS complete catalogue:

Go to our catalogue:



AKKU SYS Akkumulator- und Batterietechnik Nord GmbH

Verbindungsweg 23 · 25469 Halstenbek / Hamburg · GERMANY

Tel. +49 4101 | 3 76 76-0 / Fax +49 4101 | 3 76 76-66 / info@akkusys.de / www.akkusys.de

09/2021