



WALLBOX

User Manual

Wallbox home plus with charging socket



Wallbox home, home plus und business

Article	Article number
a-TroniX Wallbox Home	9885132
a-TroniX Wallbox Home Plus	9885176
a-TroniX Wallbox Home Plus with charging socket	9885739
a-TroniX Wallbox Business	9885123

INTRODUCTION

The publication and copyright of this documentation remain with the company

AKKU SYS Akkumulator- und Batterietechnik Nord GmbH.
Verbindungsweg 23 - 25469 Halstenbek / Hamburg - GERMANY
Phone +49 4101 | 3 76 76-0 / Fax +49 4101 | 3 76 76-66
info@akkusys.de / www.akkusys.de

Thank you very much,

for purchasing our a-TroniX series wallbox.

It is a three-phase charging station for charging electric cars with an integrated charging control, suitable for all E-vehicles type 2. The wallbox is equipped with a 5-metre charging cable (type 2 plug), which allows you to charge your vehicle comfortably and safely at any time.

Read carefully before use!

Read this manual carefully before installation.

It contains important regulations and instructions for the use of this product and provides technical support for the operator of the unit.

All rights reserved.

AKKU SYS Akkumulator- und Batterietechnik Nord GmbH cannot be held responsible for any inaccuracies or inappropriate information in this instruction manual.

The information in this document is subject to change without notice, but there is no obligation to update it on an ongoing basis.

We reserve the right to make design and equipment changes to improve the production process or the product. AKKU SYS GmbH accepts no liability for errors in this operating manual and any consequences resulting therefrom.

Table of contents

	Page
1. ABBREVIATIONS	5
2. SAFETY INSTRUCTIONS	6
2.1. Safety symbols and notes	7
2.2. Environment	8
2.3. Installation	8
2.4. Operating	9
2.5. Maintenance	9
3. STANDARDS	10
3.1. Charging mode	10
3.2. Charging connector	11
3.3. Charging connection	11
3.3.1. Case B connection	11
3.3.2. Case C connection	11
3.4. EU declaration of Conformity	11
4. PRODUCT INFORMATION	12
4.1. General	12
4.2. Block diagram	13
4.3. Product series	13
4.4. Technical specifications	13
4.4.1. Electrical parameters	13
4.4.2. Functional description	14
4.4.3. Mechanical parameters	14
4.4.4. Ambient conditions	14
4.5. Nameplate	15
5. INSTALLATION INSTRUCTIONS	15
5.1. Transport	15
5.2. Unpacking	16
5.2.1. Packing list	16
5.2.2. Unpack checking	16
5.3. Installation preparation	16
5.3.1. Safety notes for installation	16
5.3.2. Tools for installation	17
5.3.3. Ambient	17

5.4. Installation Steps	19
5.4.1. Step 1: Install the attachment	19
5.4.2. Step 2: Wiring	19
5.4.3. Step 3: hang on	20
5.4.4. Step 4: fixation	20
6. OPERATION	21
6.1. Power On	21
6.2. Interface	21
6.2.1. Information	21
6.2.2. LED indicators	22
6.2.3. LCD Display	22
6.2.4. RFID reader	23
6.2.5. Emergency stop button	24
6.2.6. Charging Port & Type2 Plug Holder	24
6.3. Start charging	24
6.3.1. Case C socket	24
6.3.2. Case B socket	24
6.4. Stop charging	25
6.5. Abnormally stop charging	25
6.6. Configure WiFi network	25
7. ERROR HANDLING AND MAINTENANCE	28
7.1. Error Handling (Troubleshooting)	28
7.2. Maintenance	30

1. ABBREVIATIONS

No.	Abbreviations	Description
1	IEC	International Electrotechnical Commission
2	EV	Electrical Vehicle, this can be BEV (battery EV) or PHEV (plug-in hybrid EV)
3	EVSE	Electric Vehicle Supply Equipment [IEC61851-1]
4	kW	Kilo Watt (unit of power)
5	A	Ampere (unit of current)
6	V	Volt (unit of voltage)
7	Hz	Hertz (unit of frequency)
8	LCD	Liquid Crystal Display
9	LED	Light-emitting Diode
10	RFID	Radio Frequency Identification
11	CMS	Central Management System Manages EVSE and has the information for authorizing users for using its EVSE.
12	OCPP	Open Charge Point Protocol A standard open protocol for communication between EVSE and a Central System and is designed to accommodate any type of charging technique. (www.openchargealliance.org)
13	IP	Ingress Protection
14	PE	Protective Earthing
15	HMI	Human-Machine Interface
16	RCCB	Residual Current Circuit Breaker
17	MCB	Miniature Circuit Breaker
19	MCCB	Moulded Case Circuit Breaker

2. SAFETY INSTRUCTIONS

- Persons installing and using chargers must observe the principles and regulations to ensure personal safety, the safety of the operating personnel and the safety of the appliance.
- Before switching on the unit, make sure that the unit is properly earthed to avoid unnecessary accidents.
- A visual inspection for damage should always be carried out before charging. In particular, the contact area of the charging plug should be checked for dirt and moisture, the charging cable should be checked for cuts or abrasions to the insulation and the cable outlet of the charger should be checked for tightness.
- Unauthorised modifications or changes to the charger will result in the immediate exclusion of the warranty.
- The charger must not be used in the vicinity of volatile gases or flammable objects.
- Before using the charger, make sure that the cables to be connected comply with the charger's specification.
- Only pull the charger cable out of the socket by the plug and not by the cable.

ATTENTION

- Only use the Wallbox in protected outdoor areas.
- Protect from moisture, rain and sunlight.

2.1. Safety Symbols and Notes

The following warning signs, mandatory signs and information signs are used in the charging station operating instructions:

Caution:



Warning of electrical hazards.

This sign is intended to alert the user that severe personal injury or substantial property damage can result if the device is not operated as requested.

Attention:



Warning of a danger spot or dangerous situation.

This sign is intended to alert the user that minor personal injury or material damage can result, if the device is not operated as requested.



Caution:

Warning of electromagnetic field.



Caution:

Warning of combustion.



No access for unauthorized persons.



No access for persons wearing pacemakers.



Use protective footwear.



Must wear a safety helmet



This symbol indicates texts, notes or tips.



Indicates recycling information.



Indicates assemblies or parts that must be disposed of properly.
Do not dispose of them in the household waste .

Environment



- EV Charging station should be installed on the incombustible such as metal; otherwise, hazardous fire may result.



- EV Charging station should not be installed in the area that contains explosive gas. Otherwise, hazardous blast may result.



- Leave no inflammable or explosive substances near the EV Charging station. Otherwise, hazardous blast may result.



- EV Charging station should be installed in a place with no conductive dust and insulation-destructive gas or vapour.



- EV Charging station should be installed in a place with no violent vibration and impact. For good ventilation, mount the charging station vertically.



- The installation foundation shall be higher than the ground level, and drainage ditch shall be set around the EV Charging station, otherwise the equipment may be damaged

2.3 Installation



- Safety protection must be done when installing the EV Charging station.



- Installation and wiring has to be done by personnel with professional qualification. Otherwise, hazardous electric shock may result



- Make sure input power supply is entirely disconnected before wiring. Otherwise, hazardous electric shock may result.



- Earth terminal of the EV Charging station must be grounded securely. Otherwise, hazardous electric shock may result.



- The lead nose of the charging station must be securely attached or there is a risk of damaging the equipment.



- Leave no metals such as bolts, gaskets into the inside of the EV Charging station. Otherwise, hazardous blast and fire may result



- Main loop terminal of the EV Charging station should be firmly connected with the wiring ends. Otherwise, damage to property may result.



- Bare parts of wiring ends of electrical cables must be wrapped with insulating tape. Otherwise, hazardous fire and property loss may result.

2.4 Operating



- Strictly forbidden for minors or persons of restricted capacity to approach the charging station to avoid injury.



- Forced charging is strictly forbidden when the electric vehicle or charging station fails.



- EV can only be charged with the engine off and stationary.



- At any time, in case of any emergency (such as fire, smoke, abnormal noise, water inflow, etc.), on the premise of ensuring personal safety, please press the red „emergency stop“ button of the charging station, and immediately stay away from the charging station. And then contact the supplier. Please use our QR code.



- It is strictly prohibited to use the charging station when the charging adapter or charging cables are defective, cracked, worn, broken or the charging cables is exposed. If you find any, please contact the supplier in time.



- Do not charge in rainy and thunderous weather.

2.5 Maintenance



- Personnel must always use protective footwear when maintenance work.



- Accessory replacement must be done by qualified personnel, thrums or metals are prohibited to be left in the controller. Otherwise, hazardous blast and fire may result.



- After replacing main PCBA, parameters must be adjusted and matched before operation. Otherwise, property loss may result.



- It is recommended that routine safety inspection visits to charging station be conducted at least once a week.



- Keep the charging connector clean and dry and wipe with a clean, dry cloth if soiled.

3. STANDARDS

3.1. Charging mode

- According to IEC 61851-1(3.1.9; 6.2.3).
- The a-TroniX-series Wallbox is an EVSE, that conforms to the Mode 3 (quick charge up to 250A).



Mode 3 is a method for connecting an electric vehicle to an AC electric vehicle supply device that is permanently connected to an AC supply network. The charging station, the charging cable and the vehicle can mutually announce the maximum possible charging power and the readiness for charging by means of a PWM signal (pulse width modulation) so that the electric vehicle becomes a controllable consumer.

3.2. Charging connector

The charging connector of the a-TroniX-series meet IEC 62196-2, type 2 (Schematic diagram shown as Fig. 3-2).

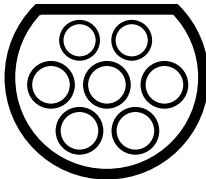

(a) type 2 socket

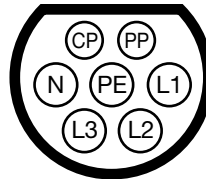

(b) 3-phase type 2 plug

Fig. 3-2 Schematic diagram of Type 2 charging socket and plug

3.3. Charging connection

3.3.1. Case B connection

Case B connection for the a-TroniX Wallbox Home Plus with charging-socket:

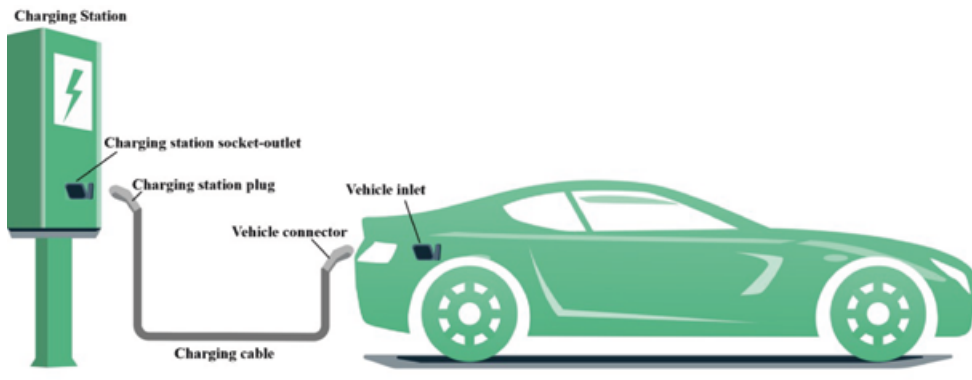

3.3.2. Case C connection

Case C connection for the a-TroniX Wallbox Home, Home Plus and Business articles:

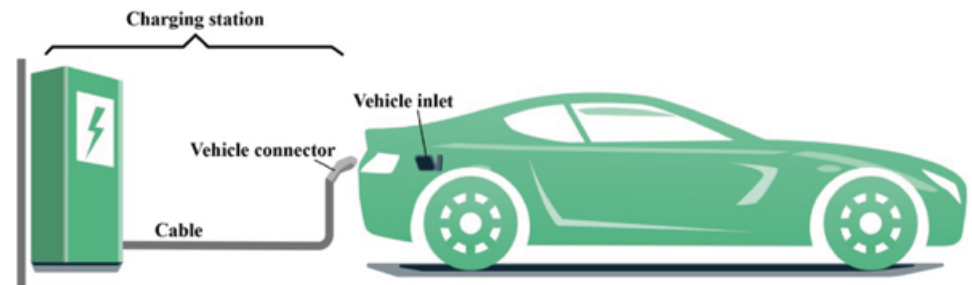

3.4. EU Declaration of Conformity

Our EU Declaration of Conformity can be found at the following link:

https://www.akkusys.de/wp-content/uploads/2021/06/Wallbox_EU-Konformitaetserklaerung.pdf

4. PRODUCT INFORMATION

4.1. General

Find out about your wallbox before installing and commissioning it.

Shape and dimensions of the a-TroniX series AC EV charging station (see Fig. 4-1):

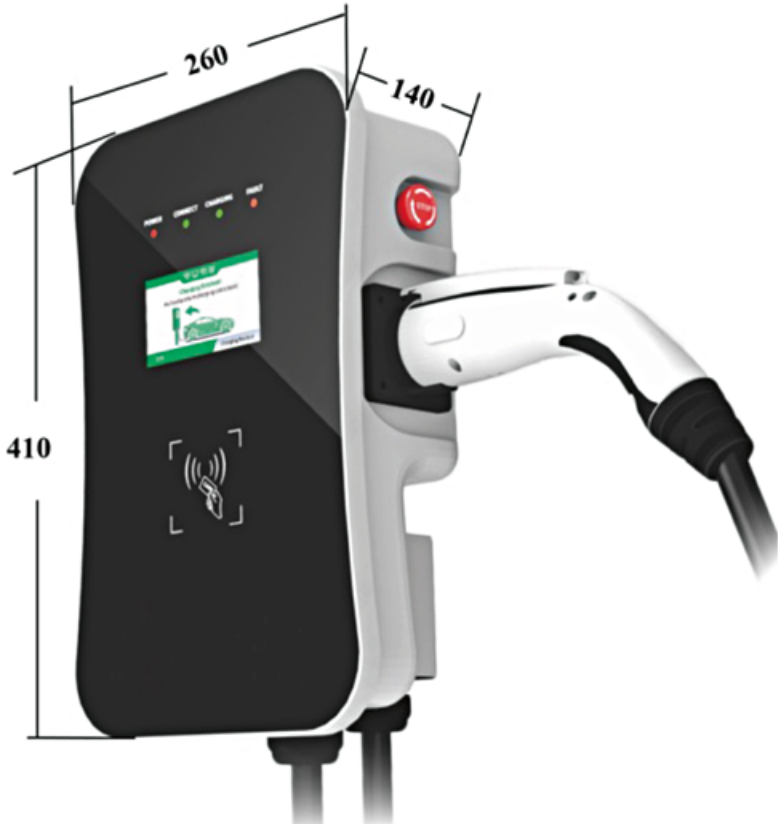

Fig. 4-1 The Shape & Dimensions of M3W

- The AC EV charging station of the a-TroniX series provides a friendly user interface with the corresponding control, measurement and communication functions.
- It is used for all types of charging of electric vehicles in private households, for various charging stations in car parks, in communal garages or for public charging stations.

4.2. Block diagram

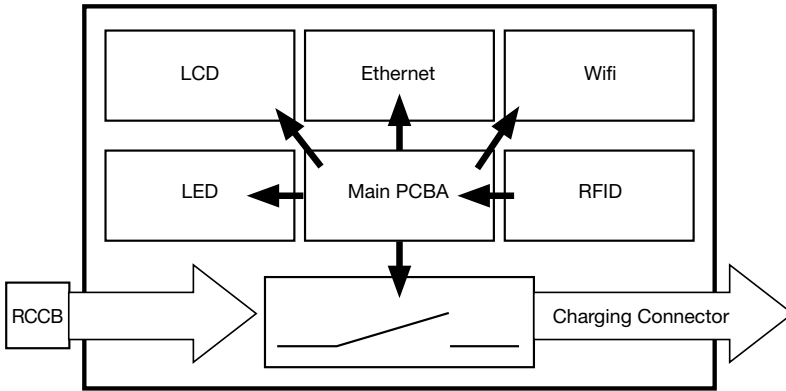

Fig. 4-2 Block diagram of the a-Tronix AC EV Charging station

4.3. Product series

3-phase products (with 3-phase type 2 plug, see Fig 3-2 (b))

Modell	Home, Home Plus	Home Plus with charging socket	Business
Rated Maximum Power	11kW (@400V, 3-phase)	11kW (@400V, 3-phase)	22kW (@400V, 3-phase)
RCCB recommended	Type B, 25A, 4-Pole	NDB1C-63C40, 3-Pole (The tripping time ≤ 10ms @ 1500A short-circuit current).	Type B, 40A, 4-Pole
Rated maximum Current	16A	16A	32A
Input cable conductor recommended size	5×4mm ² , copper	5×4mm ² , copper	5×6mm ² , copper

4.4. Technical specifications

4.4.1. Electrical parameters

1	Input Voltage	3-phase AC, 400V±10%
2	Rated frequency	50/60Hz
3	Branch breaker	Dedicated circuit
4	Input circuit terminal	L1 / L2 / L3 / N / PE

4.4.2. Functional description

1	Charging mode	Modus 3
2	Charging control	Local: „Plug-and-charge“ or „swipe card-controlled“ Remote: Smartphone APP control
3	Display screen	Optional, 4.3-inch LCD screen (display charging current, voltage, energy, charging time, state & error information, etc.)
4	Indicator lights	4 LED lights (indicate 4 status include power, connect, charging and error)
5	Communication interface	Ethernet (RJ-45 interface), WiFi (2.4GHz), RS-485 (Internal debug interface)
6	Communication protocol	OCPP 1.6
7	Safety protection	Emergency stop button, Surge protection, over temperature, over/under voltage, over current, ground protection
8	RCD inside	Yes, (Type B)

4.4.3. Mechanical parameters

1	Mounting	Wall-mounted
2	Charging connector	IEC 62196-2, Type 2, Case C (Home, Home Plus, Business) IEC 62196-2, Type 2, Case B (Home Plus with charging socket)
3	Charging cable length	5m
4	Dimension (H×W×D)	410mm × 260mm × 140mm
5	Weight	≤ 10kg
6	Color & Material	Front panel: Black, Tempered Glass Back cover: Gray, Metal Plate
7	Enclosure rated	IP54

4.4.4. Ambient conditions

1	Altitude	≤ 2000m
2	Storage temperature	-40 ~ 75°C
3	Operating temperature	-30 ~ 55°C
4	Relative humidity	≤ 95%RH, No water droplet condensation
5	Vibration	< 0.5G, acute vibration and impactation
6	Installation location	Indoor or outdoor, good ventilation, no flammable, explosive gases

4.5. Nameplate

On the back of your wallbox you will find the type plate for identification. (Fig. 4-3):



Fig. 4-3 Nameplate of charging station

5. INSTALLATION INSTRUCTIONS

5.1. Transport

When transporting or moving, please pay attention to the following points to ensure product safety:

- This product is electrical equipment. It should be handled with care to avoid violent vibration and impact.
- The front panel of the product is a glass panel, which cannot be used as a stressed part for handling.
- The charging station shall not be transported by dragging the charging connector and its charging cable.
- The back cover of the product is a sheet metal part, which should be well protected to avoid impact.

5.2. Unpacking

5.2.1. Packing list

In the package, there is a packing list, which includes:

- 1 EV-charging station (a-TroniX Wallbox)
- 1 RFID Card
- 1 set of wall-mounting accessories (including screws)
- 1 user manual

5.2.2. Unpack checking

When unpacking, please carefully confirm the following points:

- Whether the accessories are missing according to the packing list.
- Whether the model and specifications of the machine's nameplate are consistent with the order requirements.
- If damage or missing parts are found, please inform your supplier.



NOTE:

- If damage or missing parts are found, please inform your supplier.



- The packaging is recyclable. After unpacking, please keep it for reuse or dispose of it properly.

5.3. Installation preparation

5.3.1. Safety notes for installation

For further safety instructions, see section 2.



- As installation and wiring could result in a dangerous electric shock, this must be done by personnel with professional qualification.









- Make sure input power supply is entirely disconnected before wiring. Otherwise, hazardous electric shock may result.



- Operator must always notice safe protection such as wear protective footwear, wear goggles. Otherwise it may be personal injury.

5.3.2. Tools for installation

Prepare the following tools at least before installing your a-TroniX AC EV-charging station:

No. Tool	Schematic Picture	Main Uses
1 Multimeter		Check the electrical connection and measure the voltage
2 Electric Impact drill		Drill fixing holes in the wall
3 Wrench		Fastening bolt
4 Diagonal pliers		Cut the cable
5 Wire stripper		Peeling cables
6 Crimping pliers		Pressed cable terminal
7 Cross screwdriver		Fastening screw

5.3.3. Ambient

For further safety instructions, see section 2

For further environmental conditions, see section 4.4.4.

- It is suggested that the charging station should be installed in a place with good ventilation, no direct sunlight and shelter from wind and rain.
- In order to ensure good ventilation condition, you should mount the charging station vertically and leave enough space.
- Mounted the a-TroniX Wallbox on the wall is shown in Fig.5-1 and 5-1-1.
- If you purchase products with floor mounted accessories, the installation effect is similar to that of wall mounted product.

Fig. 5-1
Mounted the a-TroniX-series product
on the wall

(Home, Home Plus, Business)

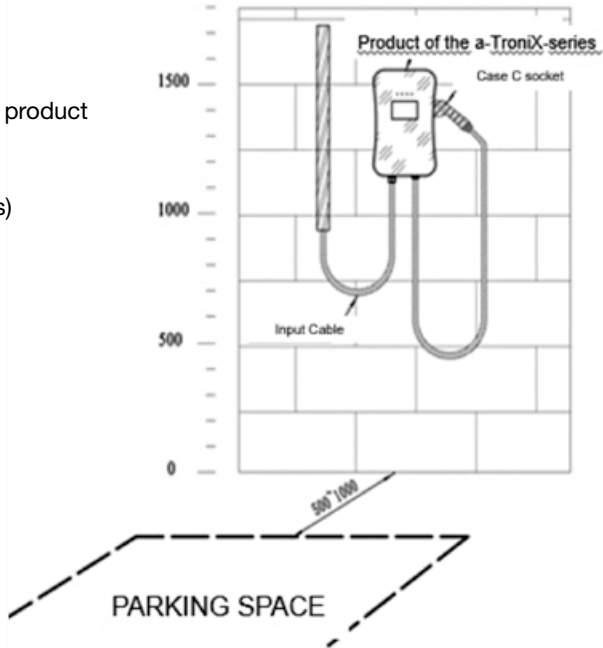
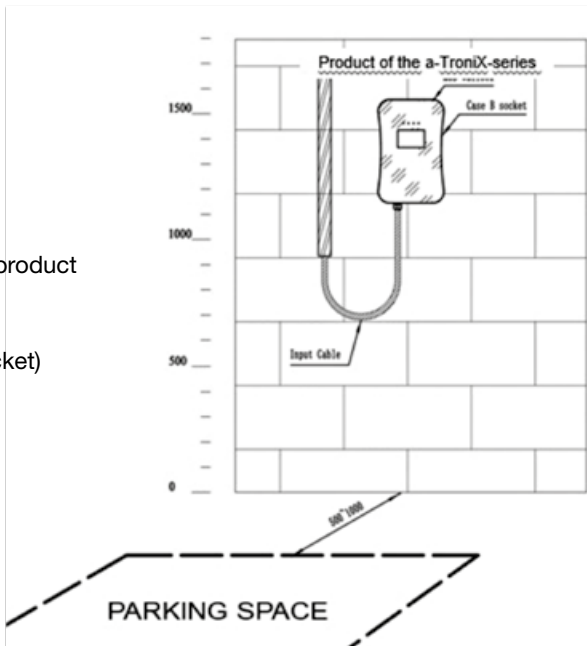

Fig. 5-1-1
Mounted the a-TroniX-series product
on the wall

(Home Plus with charging socket)



5.4. Installation Steps

5.4.1. Step 1: Install the attachment

Drill mounting holes with a diameter of 10 mm and a depth of 50 mm at the corresponding height at a distance of 130 mm × 70 mm as shown in the following Figure 4-2 and fix the mounting accessory to the wall with the expansion screws that are included in the delivery.

Fig. 5-2 Install the attachment

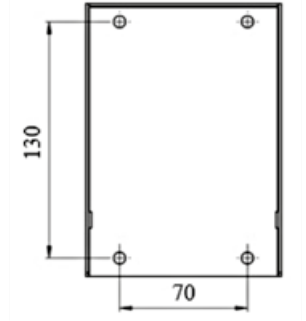

5.4.2. Step 2: Wiring

- e. Secure mounting accessories **4** to the charging station.
- f. Remove the cover of Input terminal Box **1**.
- g. Pass the input cable through the Input Cable Interface **2**, connect the power cable to the Input terminal **5**.
- h. Reset the cover of input terminal box **1**.

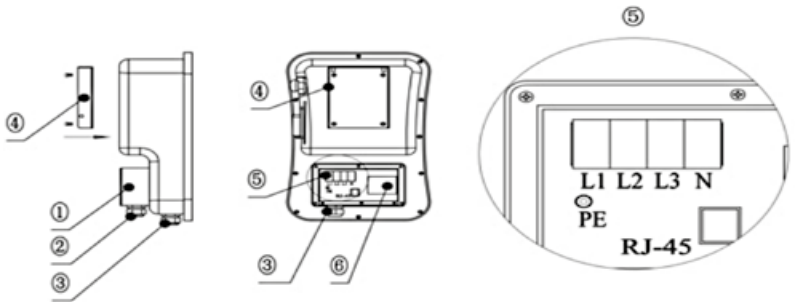

Fig. 5-3 Wiring

- | | |
|-------------------------------------|--|
| 1 Input Terminal Box | 4 Accessories |
| 2 Input Cable Interface | 5 Input Terminal (L1/ L2/L3/N/PE/RJ-45) |
| 3 Charging adapter interface | 6 MCB |

It is recommended to use flame retardant rubber copper core cable as the input cable, pass the cable through the input interface of the charging station, then fix the Neutral wire, Live wires (L1/L2/L3) and PE wire to the corresponding terminals, and finally fix the cable. If the CMS is to be connected through the network cable, put the network cable through the Charging adapter interface **3**, then crimp the RJ-45 head, and then insert it into the network cable interface.

5.4.3. Step 3: hang on

Follow the arrow, and hold the Wallbox Accessories 4 on the attachment.

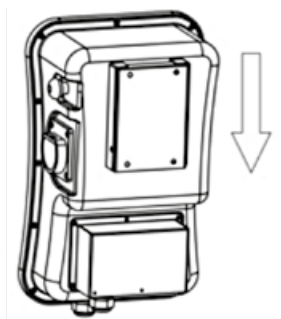

Fig. 5-4 Hang the wallbox on the attachment

5.4.4. Step 4: fixation

Tighten the set screws on the left and right ends to fixed the Wallbox.

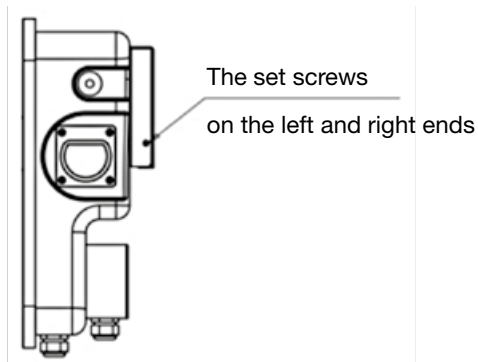

Fig. 5-5 Fixed the wallbox

6. OPERATION

6.1. Power On

After the charging station has been installed and tested, switch on the power supply. The „POWER“ indicator light lights up and the charging station switches to standby mode.

6.2. Interface

6.2.1. Information

As shown in Fig. 6-1, the a-TroniX series product is equipped with several interfaces.

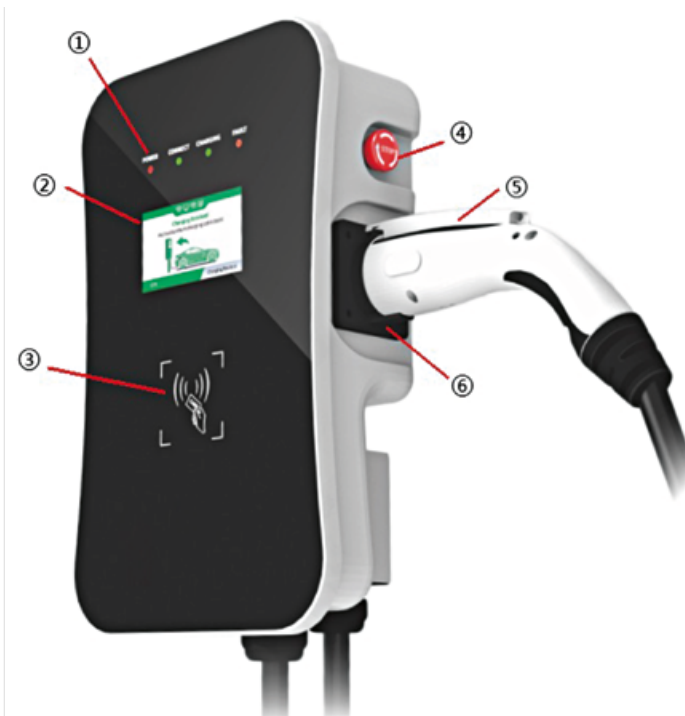

Fig. 6-1 HMI of the a-TroniX Wallbox

- | | |
|-------------------------|--|
| 1 LED indicators | 4 Emergency stop button |
| 2 LCD | 5 Charging connector |
| 3 RFID reader | 6 Empty charging connector socket (Home, Home Plus, Business) |

6.2.2. LED indicators

The LED indicators on the panel are used to indicate the status of the charging station and the various combinations of indicators are described as below.

No.	Power	Connect	Charging	Error	Connotation
	GREEN	GREEN	RED	YELLOW	
1	ON	OFF	OFF	OFF	Standby-State
2	OFF	ON	OFF	OFF	Charging adapter is properly connected to the vehicle
3	OFF	Twinkle	OFF	OFF	Starting
4	OFF	OFF	Twinkle	OFF	Charging
5	OFF	OFF	OFF	Alternately Twinkle	Error. Get the error code by the cycle flashing of the error indicator

In any state, the Power indicator is twinkle, indicating that the charging station is connected to the CMS through the network.

6.2.3. LCD Display

The LCD of the a-TroniX series is a 4.3 inch screen that mainly displays various status information of the charging station (see fig. 6-2).



a) Standby

b) Connect EV

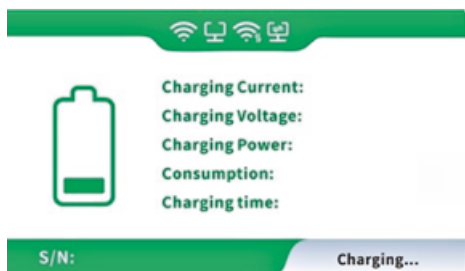

c) Charging

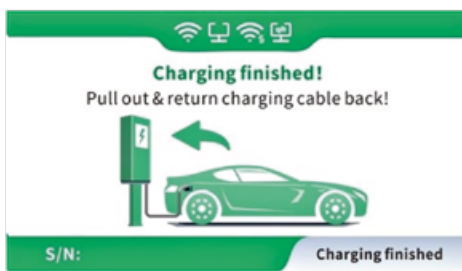

d) Charging finished



e) E-stop state

Fig. 6-2 LCD display

6.2.4. RFID reader

In general, the a-TroniX Wallbox is equipped with an RFID card reader as standard and the charging process can be started and stopped using the RFID card configured with the host (see Fig. 6-3). The special custom card swipe function is not described separately here.



Fig. 6-3 RFID card

6.2.5. Emergency stop button

This button is used to stop charging in case of emergency.

At any time, in case of any emergency (such as fire, smoke, abnormal noise, water inflow, etc.), on the premise of ensuring personal safety, please press this button, and immediately stay away from the charging station.

6.2.6. Charging Port & Type2 Plug Holder

The a-Tronix series AC EV charging station has a type 2 charging connector.

When the charging station is in standby mode, insert the charging plug into the type 2 holder to protect the charging plug.

6.3. Start charging

6.3.1. Case C socket

- a) Park the electric car, switch off the engine and apply the handbrake.
- b) Take the charging adapter out of the holder as in Fig. 6-7.
- c) Plug the charging adapter into the mains socket of the electric vehicle and the „Connect“ LED of the charging station lights up.

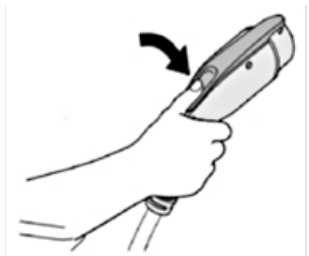

Fig.6-7 Pick off the charging connector (Case C socket)

- d) When the charging indicator starts flashing, the unit switches to the charging state.

6.3.2. Case C socket

- e) Park the electric car, switch off the engine and apply the handbrake.
- f) Users usually bring their own dual-connector charging cable (shown as Fig. 6-7-1, one connector is a type 2 male connector meet IEC 62196-2).

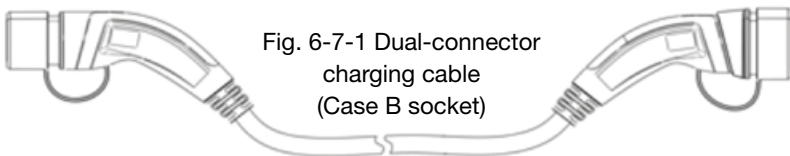

Fig. 6-7-1 Dual-connector charging cable (Case B socket)

- g) Plug the male connector into the charging station socket. And then plug another charging connector into the AC charging socket of the electric vehicle and the „Connect“ light of the charging station will be lit.
- h) For „plug-and-charge“ charging station, it will automatically enter the charging process; for „swipe card-controlled“ charging station, it needs to swipe card to start; for APP-controlled charging station, it needs to operate mobile phone to start.
- i) When the „Charging“ light begins to flash, the pile will enter the charging state.

6.4. Stop charging

a) There are two normal stoppages for „plug-and-charge“ charging station:
first, automatic stoppage with full charge, and second, manual stoppage.

b) Operation of manual stoppage:
press the unlock button of the remote key of the electric vehicle, the vehicle will stop charging (requires the support of the electric car), if the charging is not stopped, press the button of the adapter again, the charging station “Charging” indicator will go off, and the charging will stop automatically.

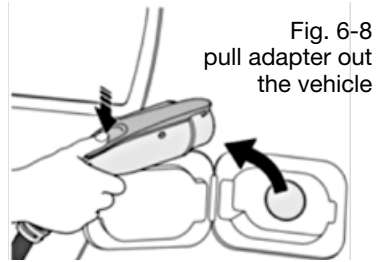

c) Pull the adapter out of the vehicle to complete charging process. If you can't pull out the adapter, usually because the vehicle is locked, press the unlock button of the vehicle key and the adapter can be pulled out.



NOTE:

- Start and stop charging for a card-controlled charging station by holding your card to the RFID reader.
- For an APP-controlled charging station, start and stop the charging process via your APP.

6.5. Abnormally stop charging

a) Emergency stop:

At any time, in case of any emergency (such as fire, smoke, abnormal noise, water inflow, etc.), on the premise of ensuring personal safety, please press the red „Emergency Stop“ button of the charging station to stop the charging process.

b) Forced error stop:

An error stop initiated by the onboard charger of vehicle.

c) Automatic error stop:

An error stop initiated by the charging station.

6.6. Configure WiFi network (with OCCP-Function)

If your wallbox is equipped with the OCCP function, proceed as follows:

Prepare a WiFi router operating at 2.4GHz and an Android or iPhone smart phone.

Make sure the charging station and smart phone are in the WiFi coverage area.

- a) Switch on the WLAN router to ensure that the router can establish a normal connection to the Internet.
- b) Turn on the smartphone's WLAN, connect the smartphone to the router via WLAN and make sure that the phone can access the Internet via the router.
- c) Install the „esptouch“ APP on your smartphone.



NOTE:

esptouch for iOS download link:

<https://apps.apple.com/cn/app/espressif-esptouch/id1071176700>;

esptouch for Android download link:

<https://github.com/EspressifApp/EsptouchForAndroid/releases/download/v1.1.1/esptouch.apk>



(for iOS)



(for Android)

- d) Open the esptouch APP, enter the password for the WiFi network name (shown as Fig. 6-4), and keep the phone in the esptouch APP, do not exit.

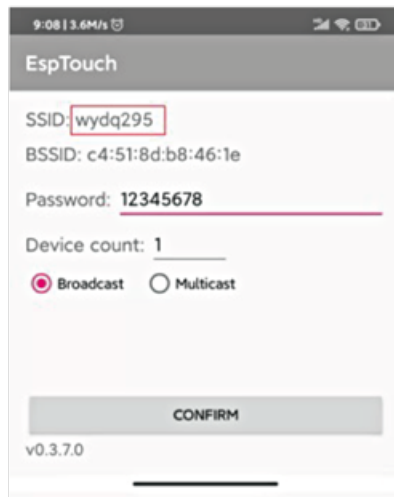

Fig. 6-4 APP interface

- e) Press and rotate to reset the emergency stop button 3 times in a row until the four indicator lights turn on in a cycle according to the running lamp mode. At the same time, the LCD screen will switch to the WiFi configuration page (shown as Fig. 6-5).

Click the „CONFIRM“ button of the APP on the smart phone.

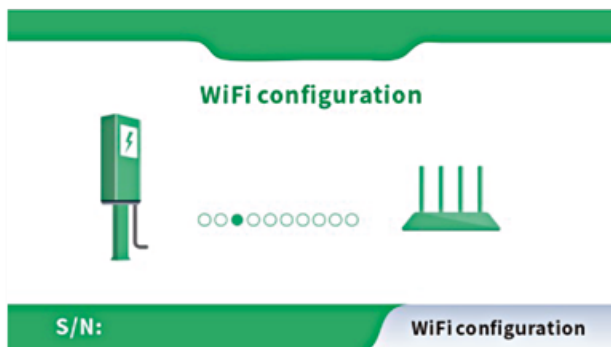

Fig. 6-5 The WiFi configuration page

- f) When all indicator lights start to flash at the frequency of 1 Hz, it indicates that the WiFi configuration of charging station is completed. At the same time, the LCD screen will display „Successful“ and the WiFi SSID name and password.

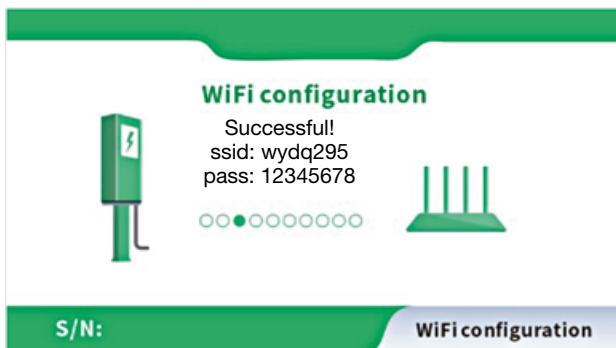

Fig. 6-6 The WiFi configuration success page

- g) Reset the emergency stop button.

7.7. ERROR HANDLING AND MAINTENANCE

7.1. Error Handling (Troubleshooting)

The charging station is automatically protected in the event of the error.
The error information and handling methods are as follows.

Error information	Error	Handling Method
Both the LED indicator lights and screen (if any) are not on		<ul style="list-style-type: none"> • Check whether the branch breaker is tripped, and close the breaker after troubleshooting. • Check whether the connection is correct, if the cable comes off, should be properly connected to tighten the cable • Check if the branch fuse is fused, and replace it after troubleshooting.
Error light flash slowly once and fast once	CP voltage anomaly	Error code 11: <ul style="list-style-type: none"> • Check that the adapter is properly connected to the electric vehicle, pull and plug the adapter and try charging again.
Error light flash slowly once and fast twice	Emergency stop	Error code 12: <ul style="list-style-type: none"> • The E-stop button is pressed, after troubleshooting, rotary the button and reset it, the Error state will exit
Error light flash slowly once and fast 3 times	Input under voltage	Error code 13: <ul style="list-style-type: none"> • Check that the input cable is reliably connected, that the parent grid is properly connected, and that the grid voltage is abnormal
Error light flash slowly once and fast 4 times	Input over voltage	Error code 14: <ul style="list-style-type: none"> • Check whether the input cable is connected correctly; Whether the grid voltage is abnormal.
Error light flash slowly once and fast 5 times	Over-temperature protection	Error code 15: <ul style="list-style-type: none"> • Check whether the charging station is covered or installed in a high temperature environment.

Error information	Error	Handling Method
Error light flash slowly once and fast 6 times	Metering error	Error code 16: <ul style="list-style-type: none"> • Power off and restart the device.
Error light flash slowly once and fast 7 times	Leakage protection	Error code 17: <ul style="list-style-type: none"> • Check whether the charging adapter and its cable are damaged or wet. Recover after pulling out the adapter
Error light flash slowly once and fast 8 times	Output shortage	Error code 18: <ul style="list-style-type: none"> • Check whether the charging adapter and its cables are damaged or wet.
Error light flash slowly once and fast 9 times	Output over current	Error code 19: <ul style="list-style-type: none"> • Check whether the charging adapter is correctly connected to the car, and check whether the on-board charger is normal
Error light flash slowly twice and fast once	Electric vehicle response timeout	Error code 21: <ul style="list-style-type: none"> • Make sure that the charging adapter is properly connected to the car, pull out and retry, or the car is full charge.
Error light flash slowly twice and fast twice	No diode at EV end	Error code 22: <ul style="list-style-type: none"> • This EV does not meet the IEC standards and cannot be charged
Error light flash slowly twice and fast three times	Relay sticking	Error code 23: <ul style="list-style-type: none"> • The device is damaged and needs to be returned to the factory for repair
Error light flash slowly twice and fast four times	Leakage detection circuit error	Error code 24: <ul style="list-style-type: none"> • The device is damaged and needs to be returned to the factory for repair
Error light flash slowly twice and fast five times	Earth error	Error code 25: <ul style="list-style-type: none"> • Charging station is not grounded; input power cable needs to be checked

7.2. Maintenance

To ensure the long-term stable operation of the equipment, please maintain the equipment regularly (usually every month) according to the operating environment.

- a) The equipment is maintained by professionals.
- b) Check whether the equipment is well grounded and safe.
- c) Check whether there are potential safety hazards around the charging pile, such as whether there are high temperature, corrosion or inflammable and explosive articles close to the charging station.
- d) Check whether the join point of the input terminal is in good contact and whether there is any abnormality. Check whether other terminal points are loose.

Other manufacturers and product ranges you will find in our **AKKU SYS** complete catalogue:



Go to our catalogue:



AKKU SYS Akkumulator- und Batterietechnik Nord GmbH

Verbindungsweg 23 · 25469 Halstenbek / Hamburg · GERMANY

Tel. +49 4101 | 3 76 76-0 / Fax +49 4101 | 3 76 76-66 / info@akkusys.de / www.akkusys.de